









|   |  |   |
|---|--|---|
|  | <h2 style="margin: 0;">OPERATING GUIDE</h2> <h3 style="margin: 0;">GRAVICOMPT UNI WITH MPLS</h3> | <p style="margin: 0;">GU 7081 EN B</p> <p style="margin: 0;"><a href="http://www.alma.alma.fr">www.alma.alma.fr</a></p> |
|---|--|---|

This document sketches out the main menus (for further information, please refer to operating manual MU 7081 EN)

#### USING THE BUTTONS

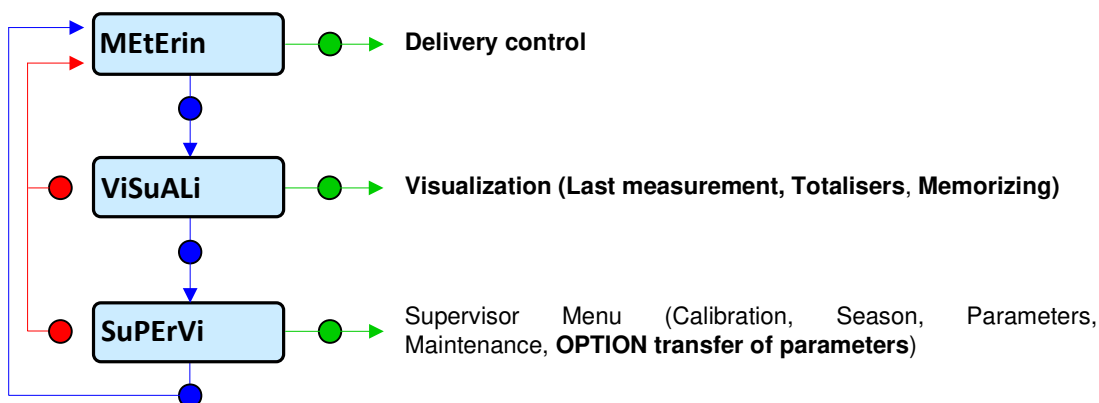
-  Come back to the previous stage ●
-  Choose the menu option ●  
 Display the delivery information
-  Validate the displayed option ●  
 Validate a fault
-  Light the display during 10 seconds



 **NB1:** Since the CTD+ key is not ATEX, it must be used outside potentially explosive area  
**NB2:** Do not plug the USB cable during data transfer.

# RUN A DELIVERY

## 1. PREPARE THE DELIVERY

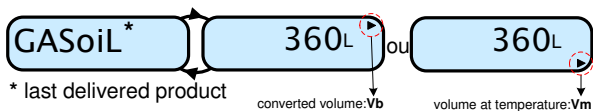

### ▲ DELIVERY AUTHORISATION

Appearance of the authorisation causes a display test and resets the volume.

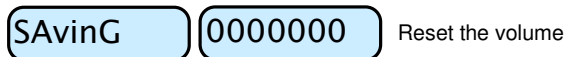

### ▲ CHOOSE THE PRODUCT

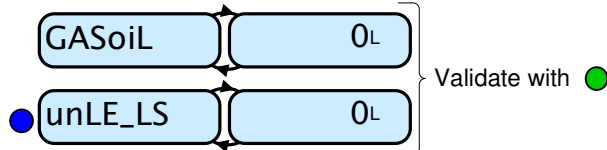

...

### ▲ CHOOSE THE DISTRIBUTION MODE

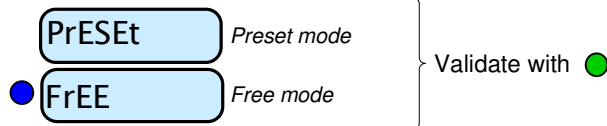

### ▲ SET THE VOLUME ⚠with PRESET MODE



- Change the blinking figure value
- Access to the following figure
- Validate

## 2. CARRY OUT THE DELIVERY



### CHECK THE CHOSEN PRODUCT

NOTE: The unit of flowrate and volume depends on the settings chosen.

### ▲ START THE DELIVERY

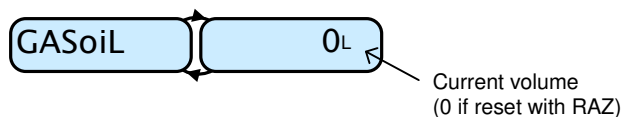

### ▲ DISPLAY THE DELIVERY INFORMATION

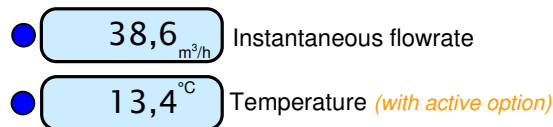

### ▶ APPEARANCE OF A FAULT AND DISPLAY OF AN ALARM

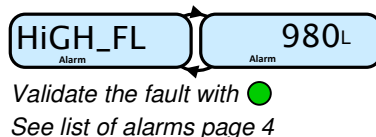

## The delivery may be interrupted by several situations

### ▶ THE COMPARTMENT IS EMPTY

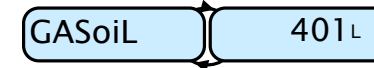

Wait the blinking display

- ▼ Close the valve
  - End the delivery (§3)
  - Continue delivery (§2)

### ▶ INTENTIONAL INTERRUPTION OF THE DELIVERY

▼ The delivery may be interrupted at any time :



- ▼ Close the valve
  - End the delivery (§3)
  - Continue delivery (§2)

## 3. FINISH THE DELIVERY

### ▲ DELIVERY AUTHORISATION

When the delivery authorisation is removed, the measurement is ended and recorded. Back to §1

### MEANING OF SYMBOLS

- ▲ Mandatory action
- ▲ Optional action (depends on configuration choosen)
- ▶ Event during delivery
- ▼ Action by operator

# DISPLAY/TRANSFER\* THE DELIVERY DATA

## VISUALIZATION OF THE LAST DELIVERY RESULTS - sub-menu **MEtErin**

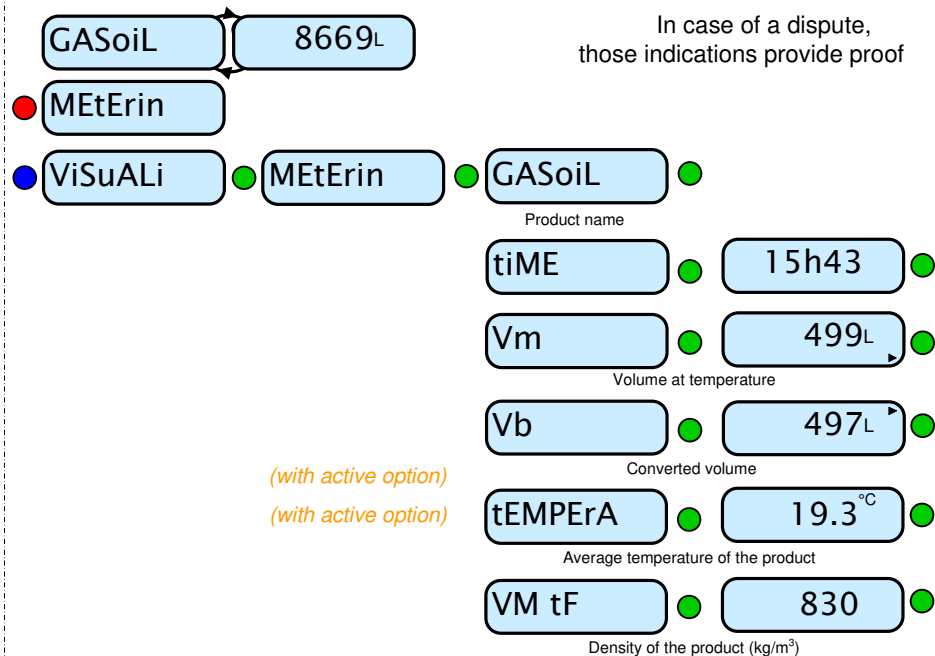

## VISUALIZATION OF ALL THE DELIVERY RESULTS - sub-menu **MEMoriS**

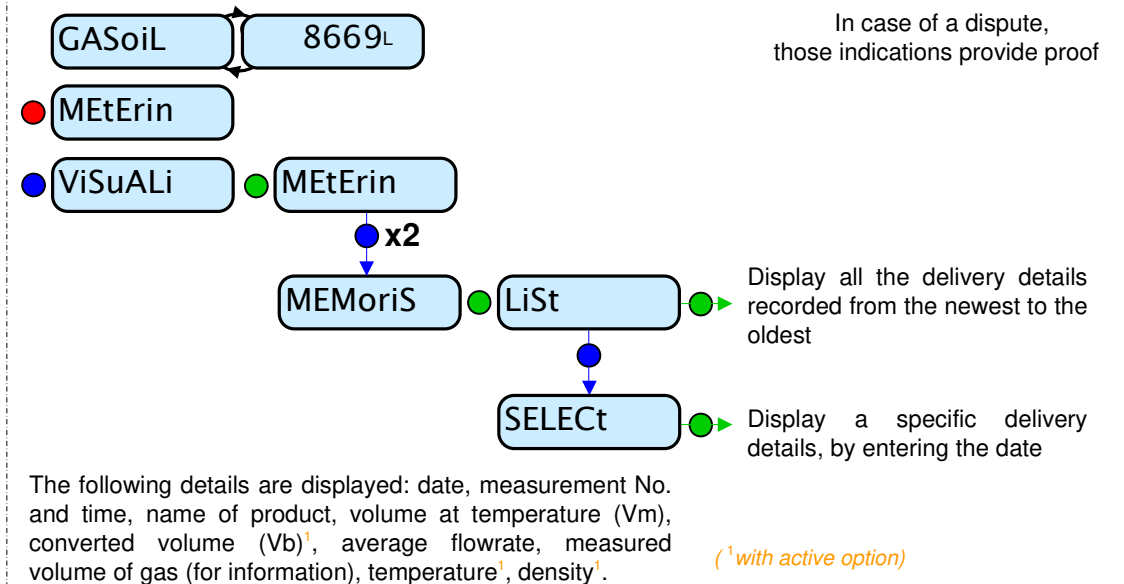

## VISUALIZATION OF THE TOTALISERS - sub-menu **totALiS**

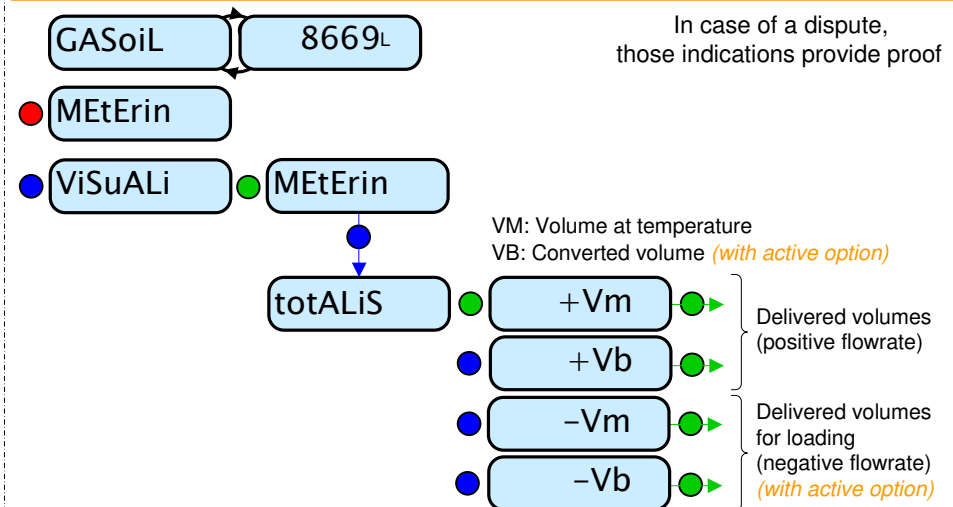

## \*OPTION KEY CTD+: TRANSFER MEASUREMENT DATA

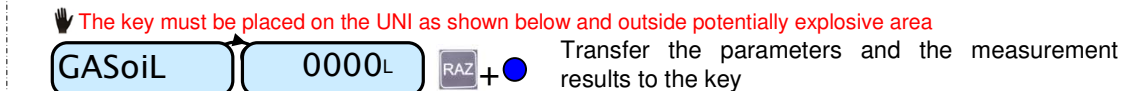

## \*OPTION KEY CTD+: TRANSFER MEASUREMENT DATA - sub-menu **trAnSFr**

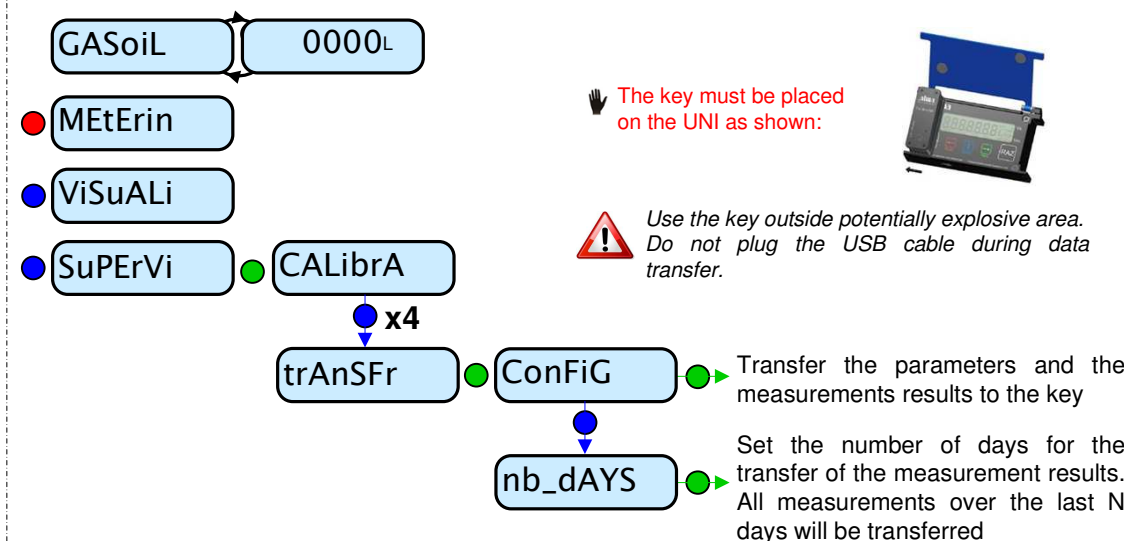

# LIST OF ALARMS

|           |   | DISPLAY                                  | MEANING  | ACTION  |
|-----------|---|--|--|---|
| USER      |   | oVerFlo                                  | Volume greater than 4 194 304 liters   | Reset the device  |
|           |   | LoW_FLo                                  | Flow rate less than the setting minimal flow rate                                  | Check the hydraulic configuration and the flowing             |
|           |   | SEnSor1                                  | High gas detector fault (GDh)  | Use the maintenance menu to check the status of the detector  |
|           |   | SEnSor2                                  | Low gas detector fault (GDI)   | Use the maintenance menu to check the status of the detector  |
|           |   | dirECti                                  | Flow direction change during metering  | Check the hydraulic configuration and the flowing             |
|           |   | FAiL                                     | Problem with the transfer of the files to the CTD+ key                             | See GU 7110   |
| MPLS      |   | StoP                                     | Intentional interruption of delivery   | Stop delivery   |
|           |   | Author                                   | The autorisation has been removed during pouring                                   | The measurement is ended                                      |
|           |   | LEAK                                     | Counting of a volume greater than or equal to 1 liter (metering off)               | Acknowledge the alarm to end measurement                      |
|           |   | dEFPREd                                  | Volume $\geq$ preset volume+1% the minimum quantity                                | Acknowledge the alarm   |
| REPARATOR |   | FLoV_                                    | Flow setting fault   | Check the parameters  |
|           |   | FrEQ_                                    | Frequency fault  | Check the parameters  |
|           |   | COEFF_                                   | Difference two coefficients is greater than 0,5%                                   | Check the coefficients setup                                  |
|           |   | MEtEr                                    | Problem of metering with the meter   | Check the setup   |
|           |   | HiGH_FL                                  | Flow rate greater than the setting maximal flowrate                                | Check the setup   |
|           |   | LF_HiGH                                  | Flow greater than 20m <sup>3</sup> /h while GDh dry                                | Check the setup   |
|           |   | dAtE                                     | Loss of date and time  | Set date and time in metrological mode                        |
|           |   | GAS                                      | GDh is wet but GDI is dry  | Check the hydraulic configuration / Check the detector status |
|           |   | VALvE                                    | GDh is dry and the delay volume is flowed out for over 2 seconds                   | Check the setup / Check the valve is operating properly       |
|           |   | drY MEt                                  | When using a pump. The volume of gas is greater than the minimum measured quantity | Stop metering   |
|           |   | Coil                                     | Loss of pulse transmitter signal   | Check the connection with the pulse transmitter               |
|           |   | tEMPErA                                  | Temperature less than -20°C or greater than 50°C                                   | Check the temperature sensor (measure and calibration)        |
|           |   | diSPLAY                                  | LCD display fault  | If steady alarm, substitution of the UNI                      |
|           |   | doG                                      | Fault with card  | If steady alarm, substitution of the UNI                      |
|           |   | ProGrAM                                  | Error on the cheksum of the metrological data                                      | If steady alarm, substitution of the UNI                      |
|           |   | rAM                                      | Saved memory fault   | If steady alarm, substitution of the UNI                      |
|           |   | MEMoriS                                  | Bad writting into the memory   | If steady alarm, substitution of the UNI                      |
|           |   | FuLL                                     | If a measurement result, not older than 3 months, is about to be erased            | If steady alarm, substitution of the UNI                      |
|           |   | MEtro_                                   | Configuration loss   | If steady alarm, substitution of the UNI                      |
|           |   | bAttErY                                  | Low battery  | Substitution of the batteries                                 |
| totAL_    | Totaliser fault   | If steady alarm, substitution of the UNI |  |   |
| dEF_MEM   | Loss of backup data concerning the last measurement                                     | If steady alarm, substitution of the UNI |  |   |
| dEF_CoM   | Communication fault with IRDA link  | Check the IRDA link                      |  |   |
| rECEPt    | Problem of communication protocol between the calculator-indicator UNI and the CTD+ key | Check the devices compatibility          |  |   |