

OPERATING MANUAL

AUTONOMOUS FLEXICOMPT+

MEASURING SYSTEM FOR GRAVITY MEASUREMENT

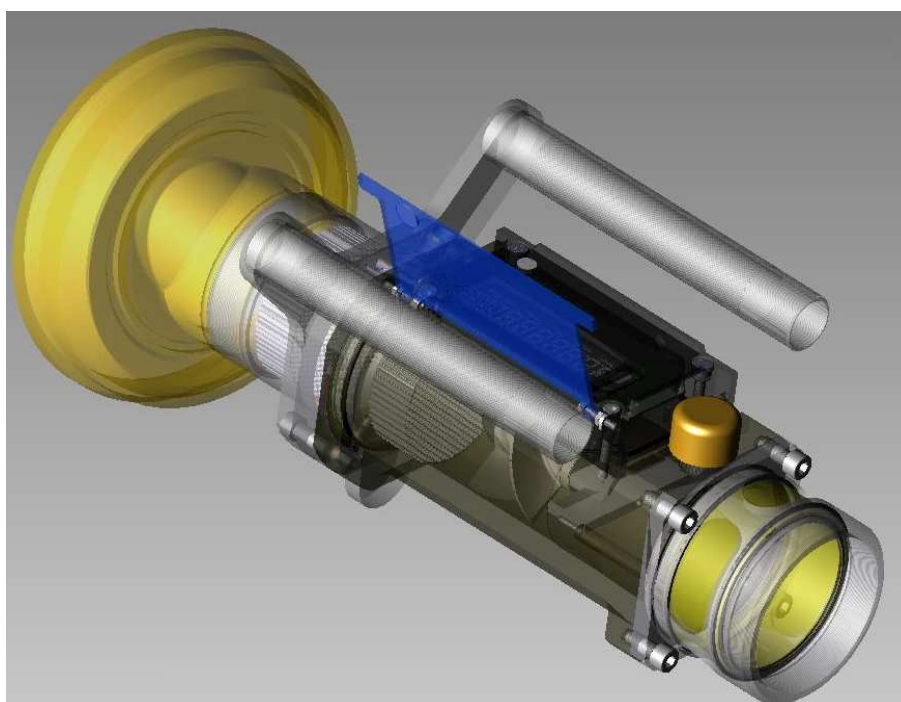

Document available for software: 434 from version: 1.04

B	10/06/10	Updating with software 434 V1.04	DSM	XS
A	26/02/09	Creation – Replace MM5014-EN-4	FM	DSM
Rev.	Date	Nature of modifications	Writer	Approb.

	MU 7033 EN A AUTONOMOUS FLEXICOMPT+	Page 1/14
	Alma Ingénierie (Service Technique)	

SUMMARY

1. GENERAL PRESENTATION AND DESCRIPTION	3
2. USER RECOMMENDATIONS.....	4
3. IGNITION AND OPERATION	5
4. USER MODE.....	5
4.1 METERING MENU	5
4.2 METERING OFF (current volume to zero).....	6
4.2.1 VISUALISATION MENU	6
4.2.1.1 METERING SUBMENU	6
4.2.1.2 TOTALISER SUBMENU	6
4.2.1.3 MEMORISATION SUBMENU	7
4.2.2 SUPERVISOR MENU	7
4.2.2.1 CALIBRATION SUBMENU	8
4.2.2.2 SEASON SUBMENU	8
4.2.2.3 PARAMETERS SUBMENU.....	9
4.2.2.4 MAINTENANCE SUBMENU.....	10
4.3 FAULTS LIST	11
5. METROLOGICAL MODE	12
5.1 REFERENCE, TURBINE, COEFFICIENT, VMFT.....	13
5.2 FLOW RATES, VOLUMES	13
5.3 TEMPERATURE, GAS DETECTORS, THRESHOLDS, CONTRAST, DATE, IRDA.....	14



1. GENERAL PRESENTATION AND DESCRIPTION

The AUTONOMOUS FLEXICOMPT+ is intended to the gravity measurement of products other than water on various installations.

It can:

- measure products when they are delivered to the station,
- monitor the reception of products (lorry/wagon),
- split compartments,
- measure product returns,
- and issue tank charts.

The AUTONOMOUS FLEXICOMPT+ includes:

- an intrinsic security indicator-calculator device, type UNI, powered by 2 lithium batteries (4 years life expectancy) fastened to the hydraulic sleeve,
- a hydraulic measuring sleeve composed of:
 - o an ALMA turbine meter, type ADRIANE DN80-80,
 - o a sight glass located downstream of the turbine meter,
 - o a vacuum breaker valve,
- an appropriate connector: a 4" coupler to connect onto the API adapter, a DN80 quick coupling to connect the unloading hose or any other connector (TODO, aviation,...)
- an appropriate unloading connector: a quick coupling to connect the unloading hose or any other connector (TODO, aviation,...).



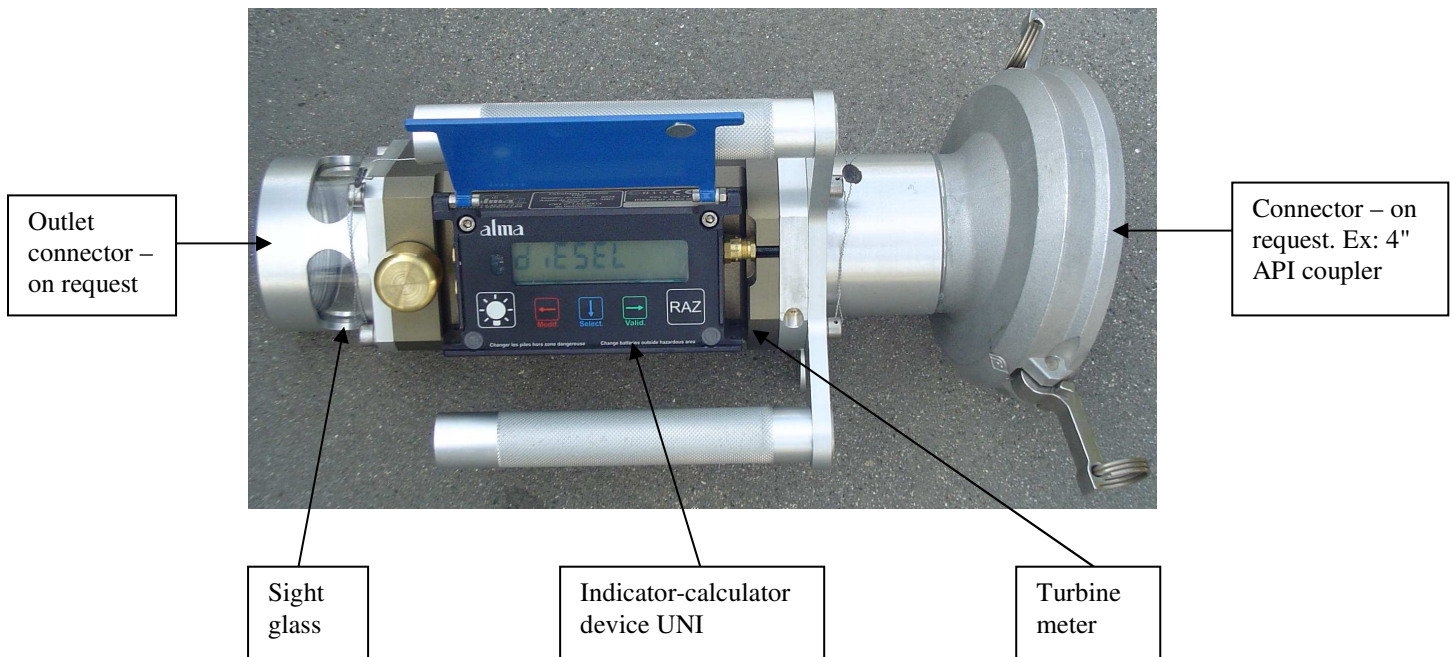

The AUTONOMOUS FLEXICOMPT+ may be connected to a temperature probe.



The indicator-calculator device, type UNI guarantees the metering operation and manages the faults linked with the metering system.

The operating temperature for the UNI is between -20°C and +50°C.

On the front of the UNI, you can see five buttons:

- BP5  Light the display during 10 seconds
- BP4  Normal mode: return to previous menu
Metrological mode: increment the flashing figure when imputing a value
- BP3  Normal mode, metering off: select the menu
Normal mode, metering on: display the values (immediate flow, temperature)
Metrological mode: select the figure to be modified
- BP2  Normal mode: validate the selected menu or value
Metrological mode: validate the displayed value
In case of default: acknowledge the default
- BP1  Reset the volume to zero before a new measurement. The data of the last measurement are then recorded

2. USER RECOMMENDATIONS

When using the AUTONOMOUS FLEXICOMPT+ in gravity mode, the operator must make sure that all of the following conditions are satisfied:

- the tank operating position does not differ by +/- 2° (dependant from tank design, refer to tank manufacturer) from the horizontal reference position (to avoid product retention)
- when measuring, FLEXICOMPT is fixed on the API outlet of the tank at an angle of 15° minimum to the horizontal;
- the unloading hose must be installed to ensure an easy outflow during delivery (without product retention, avoid high points). The maximum length of the discharge hose (3" diameter) is 12 metres;
- the operator must remain beside the metering system during delivery to stop the flow, if necessary, by closing the API valve on the outlet of the tank compartment .

NB: the AUTONOMOUS FLEXICOMPT+ cannot be used for pumped applications.

3. IGNITION AND OPERATION

The AUTONOMOUS FLEXICOMPT+ measuring system operates with an empty hose. The operator connects hydraulic sleeve to the API adaptor and then connects the hose to the sleeve outlet.

The operating procedure is as follows:

- After having reset the indicator to 0 (BP1 RAZ), the operator turns the outlet release lever on the compartment to be emptied. The metering starts as soon as the indicator – calculator device records impulses coming from the turbine. The metered volume is continually displayed on the indicator-calculator device.
- For partial emptying:
The operator stops metering by closing the compartment outlet valve. The metering stops when the indicator-calculator device notes that the two gas detectors are wet and flow rate is to zero.
- For complete emptying:
The operating procedure is identical to the partial emptying procedure but there is no voluntary action on the compartment outlet valve.

4. USER MODE

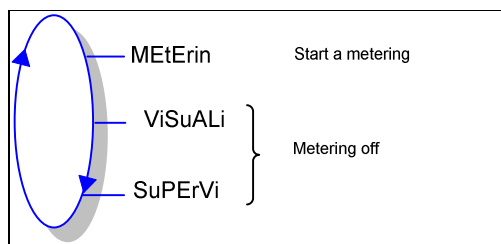

The UNI metering can be either on or off. Metering is ON between the first command level after initialisation or resetting the current volume to zero, and resetting the current volume to zero.

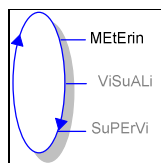

4.1 METERING MENU

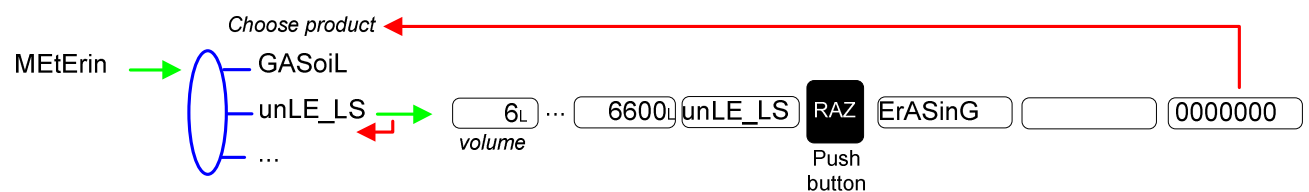

Use BP2 to display flow rate (and temperature) during measuring.

Pressing BP1 RAZ allows the recording of the last measurement data and reset the volume to zero.

4.2 METERING OFF (current volume to zero)

The operator can access various menus and sub-menus by using **BP3** to select the menu, **BP2** to validate the displayed menu or value, **BP4** to return to the previous menu.

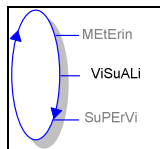

4.2.1 VISUALISATION MENU

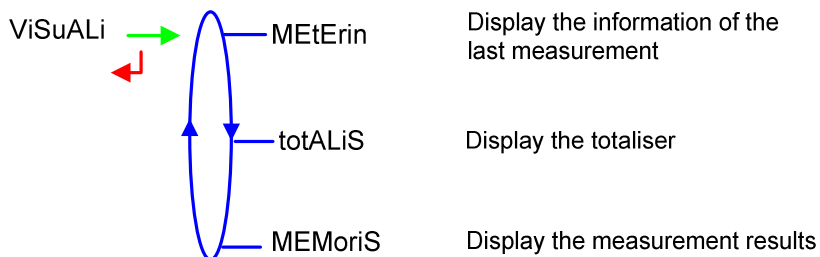

4.2.1.1 METERING SUBMENU

This menu displays the information of the last measurement.

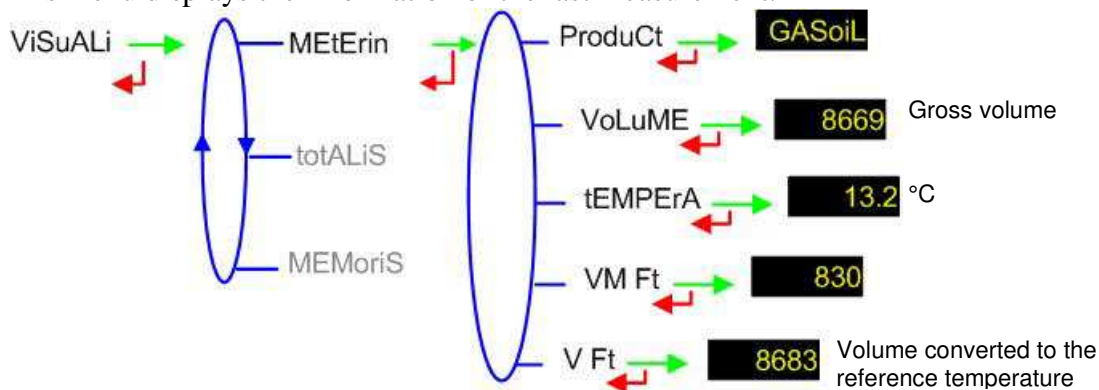

4.2.1.2 TOTALISER SUBMENU

This menu displays the totaliser.

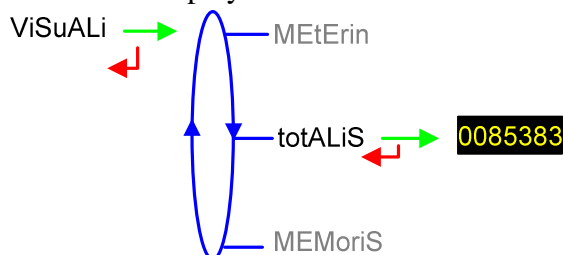

USER

4.2.1.3 MEMORISATION SUBMENU

This menu displays the measurements results.

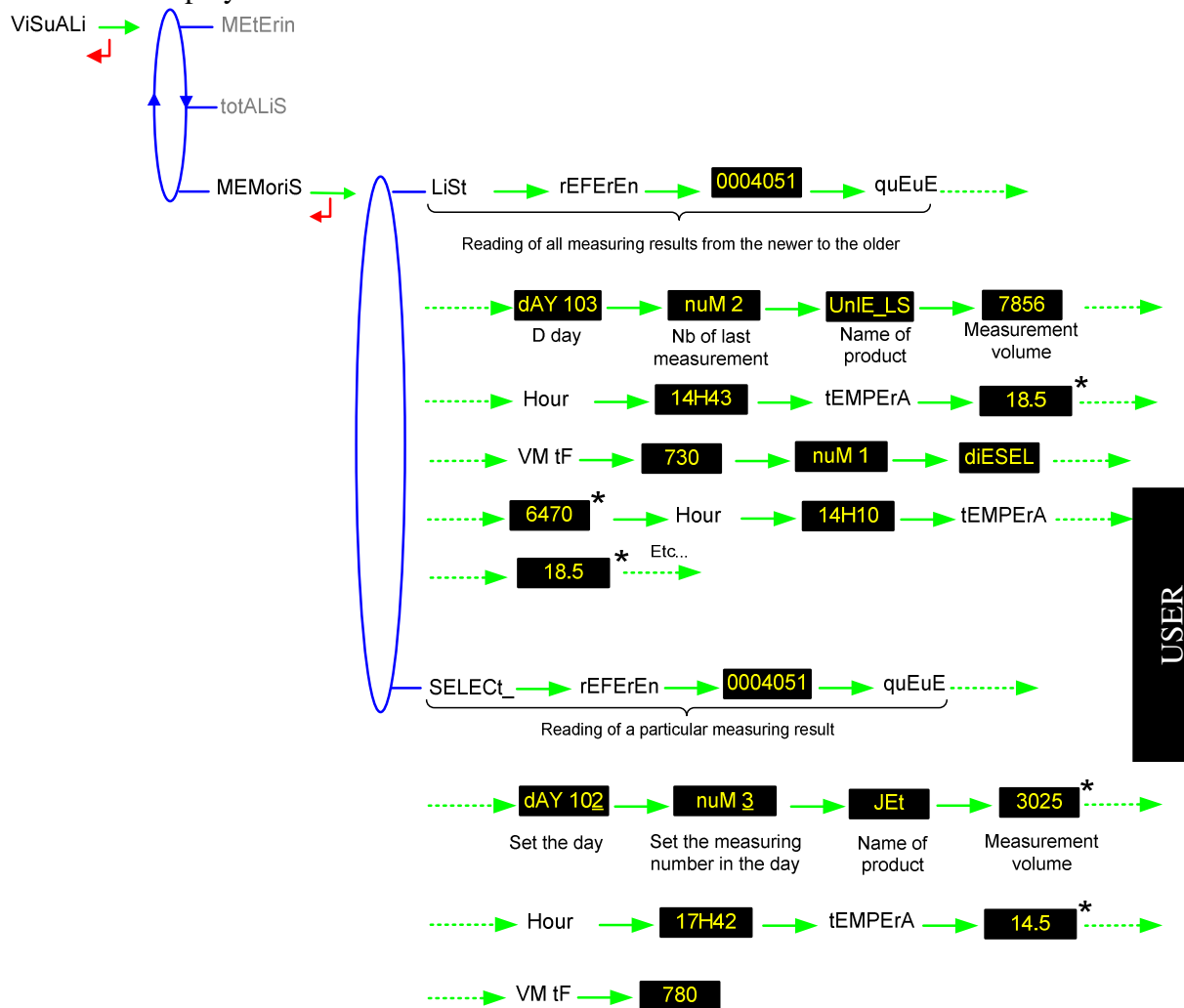

*These values may be preceded by this display: ----- Its means they are no longer guaranteed

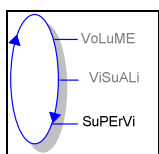

4.2.2 SUPERVISOR MENU

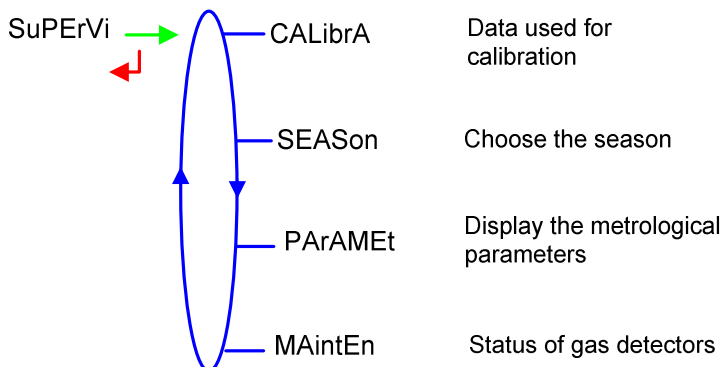

4.2.2.1 CALIBRATION SUBMENU

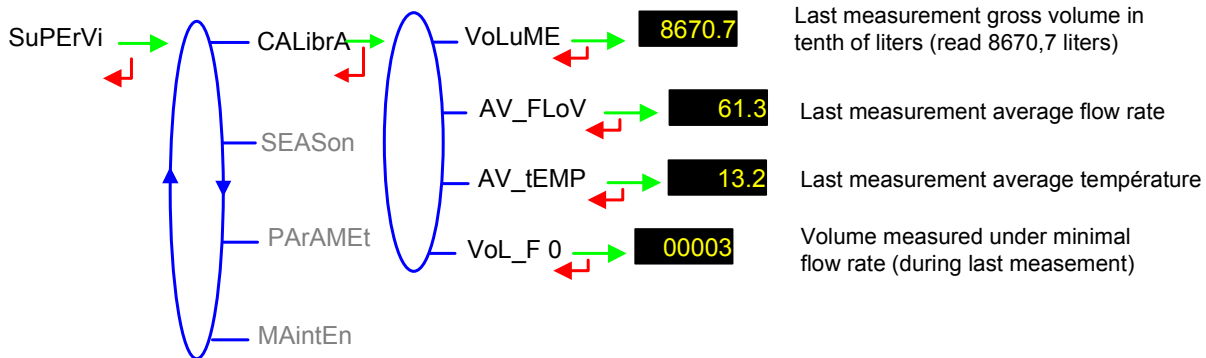

4.2.2.2 SEASON SUBMENU

This menu is for choosing season.

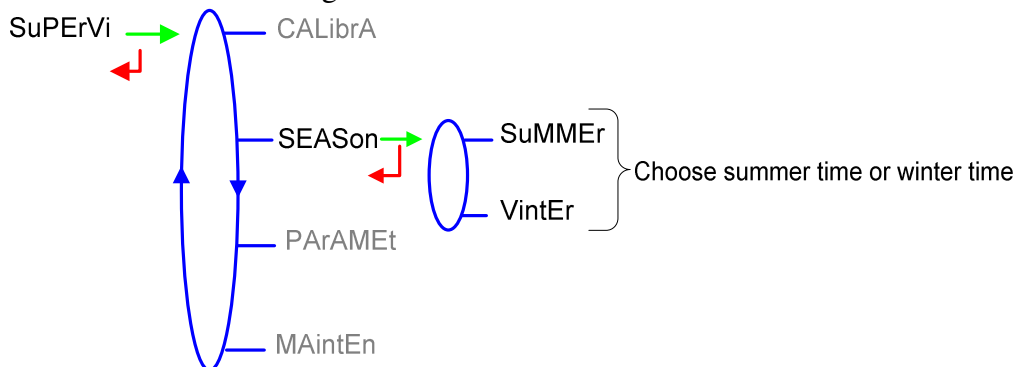

USER

4.2.2.3 PARAMETERS SUBMENU

This menu displays the parameters set in metrological mode and gives the product temperature.

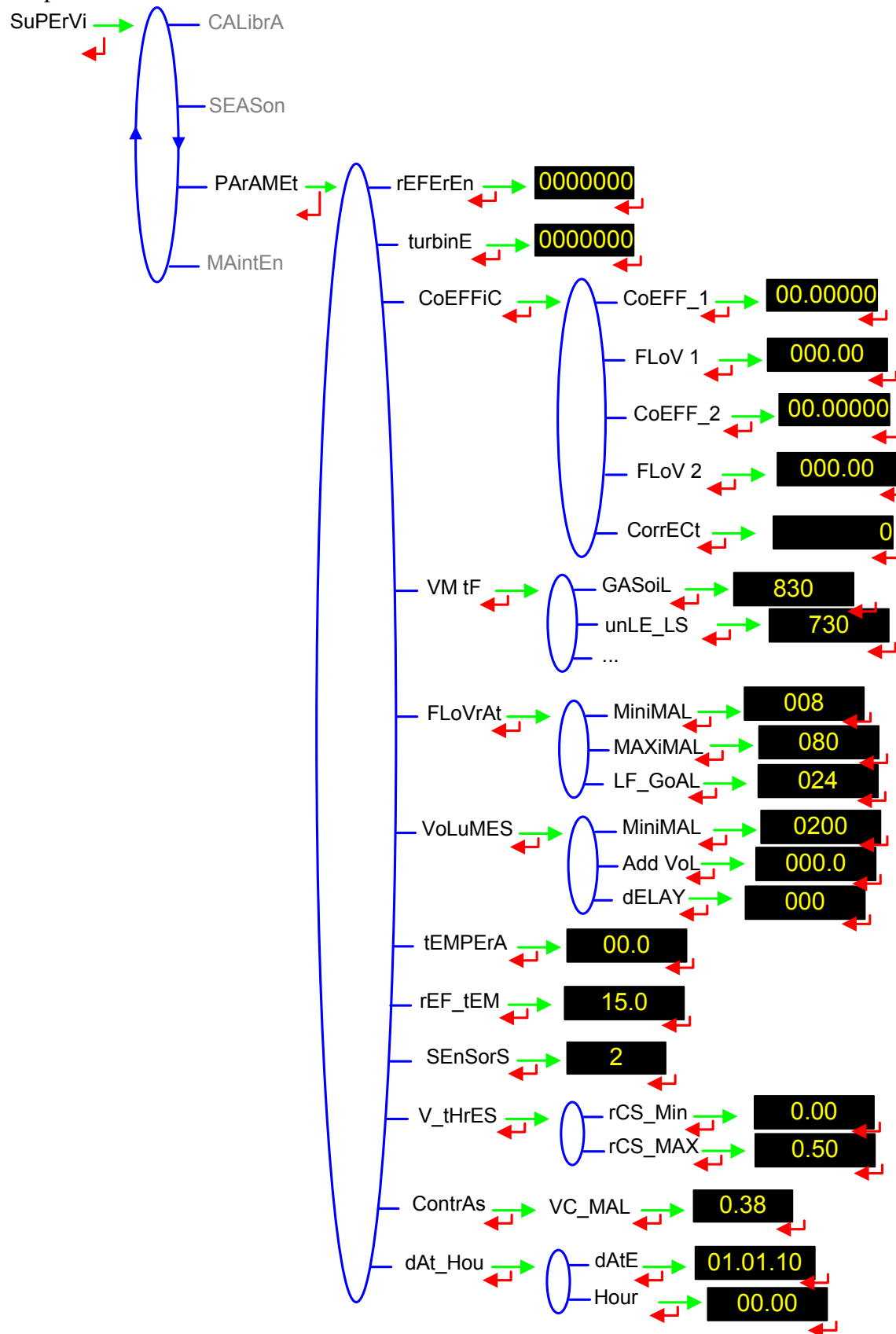

4.2.2.4 MAINTENANCE SUBMENU

This menu displays the drain current (mA) of the gas detectors and the reference current set in metrological mode.

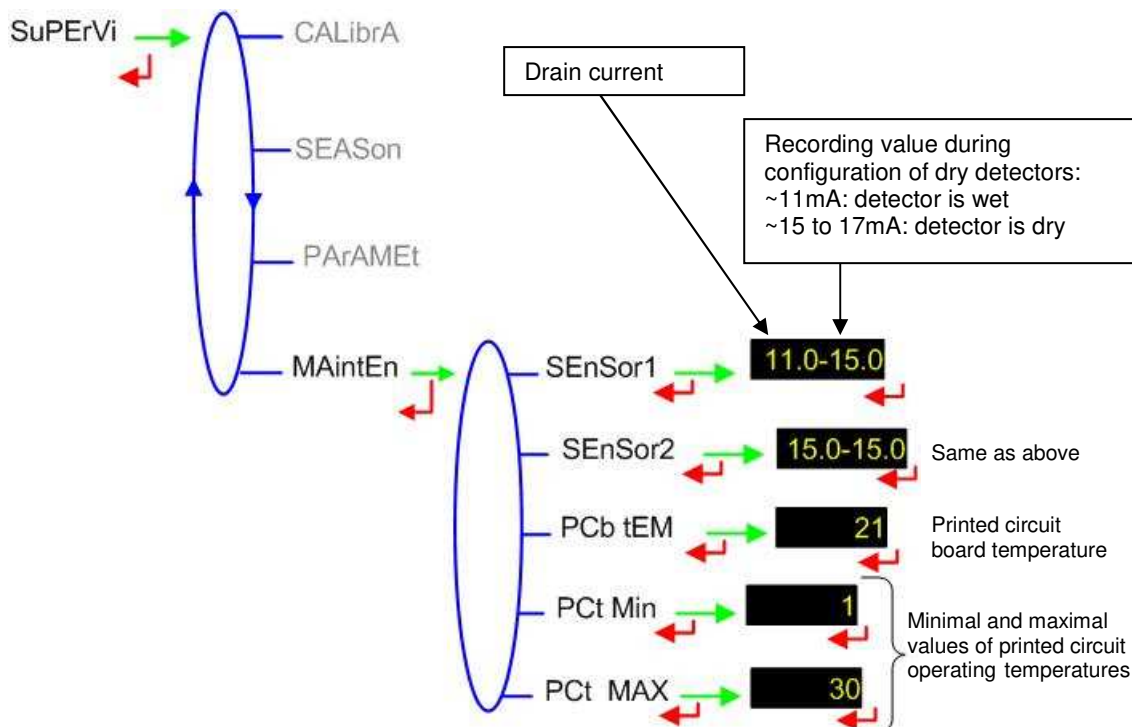

4.3 FAULTS LIST

Should a fault occur, the UNI displays the word "Alarm" and the fault title on the display (using some or all of the seven digits) followed by the displayed value . The operator acknowledges the fault by pressing down BP2 (even when pouring). Apart from battery related faults, persistent faults cannot be acknowledged.

Once the fault is acknowledged, the selected value is displayed alternately with "-----" to indicate that the measured values are no longer guaranteed.

ALARM	FAULT
ProGrAM	Checksum program fault
rAM	Metrological configuration RAM fault
Faults acknowledgeable in METROLOGICAL mode	
MEtro_	Configuration loss
COEFF_	Coefficient fault
dAtE	Date loss
FLoV_	Flow setting fault
FrEQ_	Frequency fault
MEMoriS	Memory fault
Faults acknowledgeable	
dEF_MEM	Loss of backup data concerning the last measurement
SEnSor1	High gas detector fault (GDh)
SEnSor2	Low gas detector fault (GDI)
LoW_FLo	Flow rate less than the setting minimal flow rate
HiGH_FL	Flow rate greater than the setting maximal flowrate
LF_HiGH	Flow rate greater than 20m ³ /h when GDh is dry
GAS	GDh is wet but GDI is dry
doG	Watch dog fault
ovErFLo	Volume greater than 9 999 999 liters
MEtEr_	Discordance between the two metering channels above Qmin
bobinE	Loss of pulse transmitter signal
dEF CoM	Communication fault
totAL	Totaliser fault
diSPLAY	LCD display fault
FuLL	Saturation of secured memorisation: more than 99 measurements per day
bAttErY	Battery fault
tEMPErA	Temperature less than -20°C or greater than 50°C

5. METROLOGICAL MODE

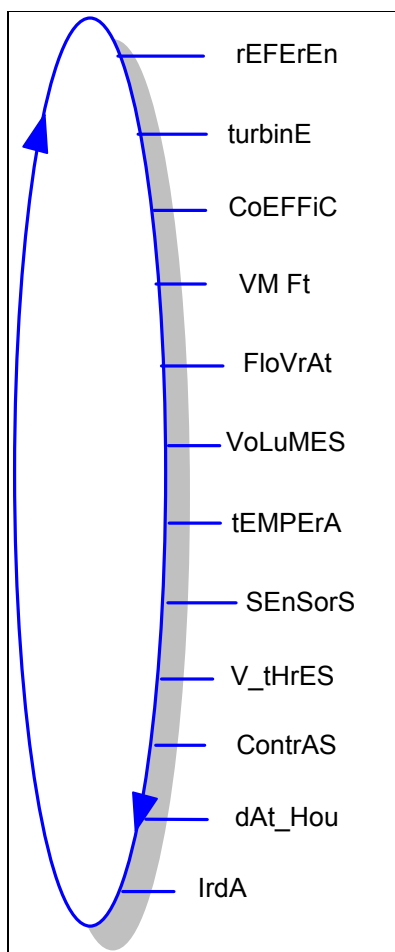

The configuration parameters can only be modified after the processor configuration switch on the electronic card has been switched over. Only authorized personnel can modify these parameters. All other interventions must be carried out by authorised personnel since the metrological character of the AUTONOMOUS FLEXICOMPT+ may be modified.

IMPORTANT

Setup should be done under cover, metering off, with dry gas detectors (see § 4.2.2.4).

5.1 REFERENCE, TURBINE, COEFFICIENT, VMFT

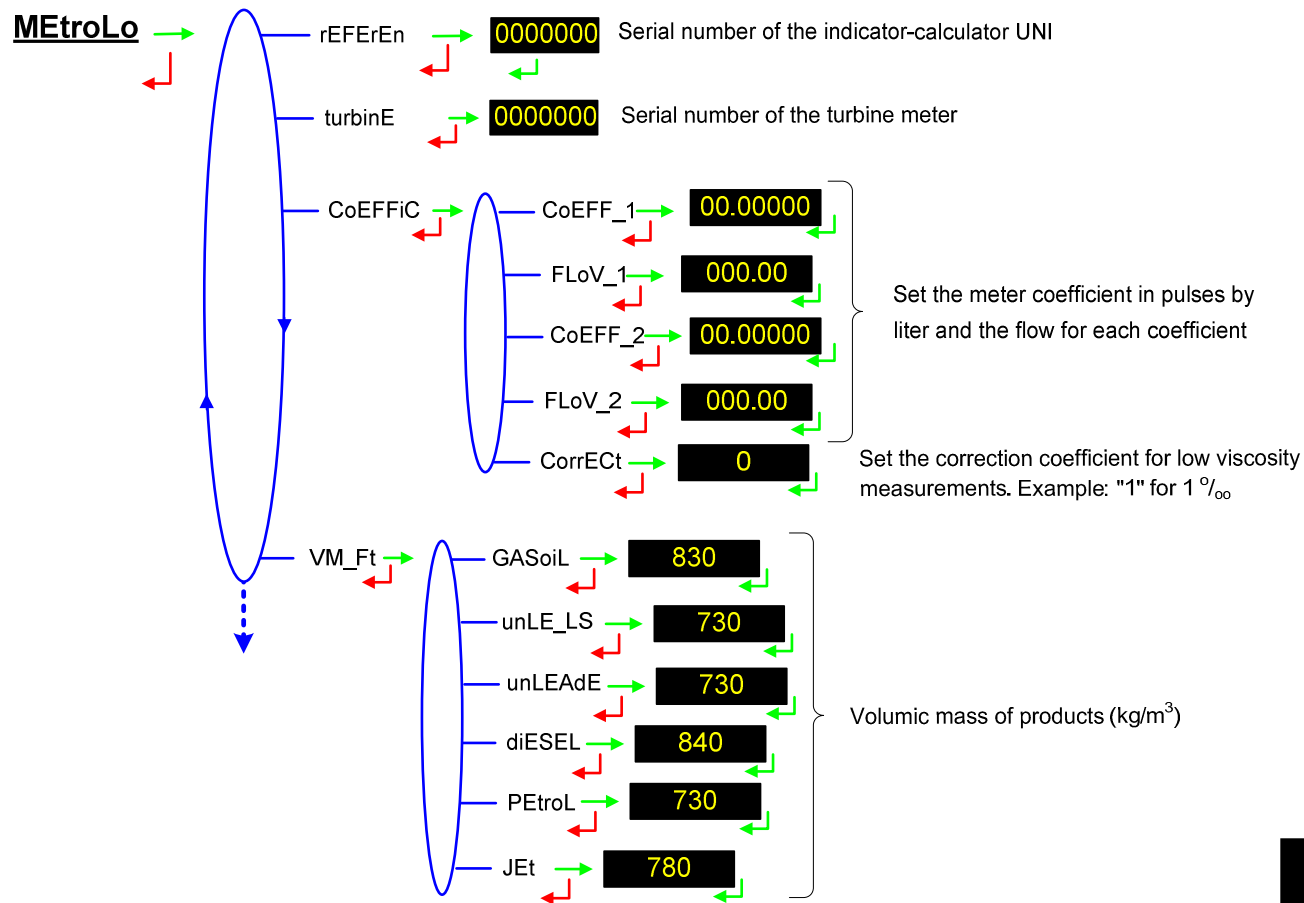

5.2 FLOW RATES, VOLUMES

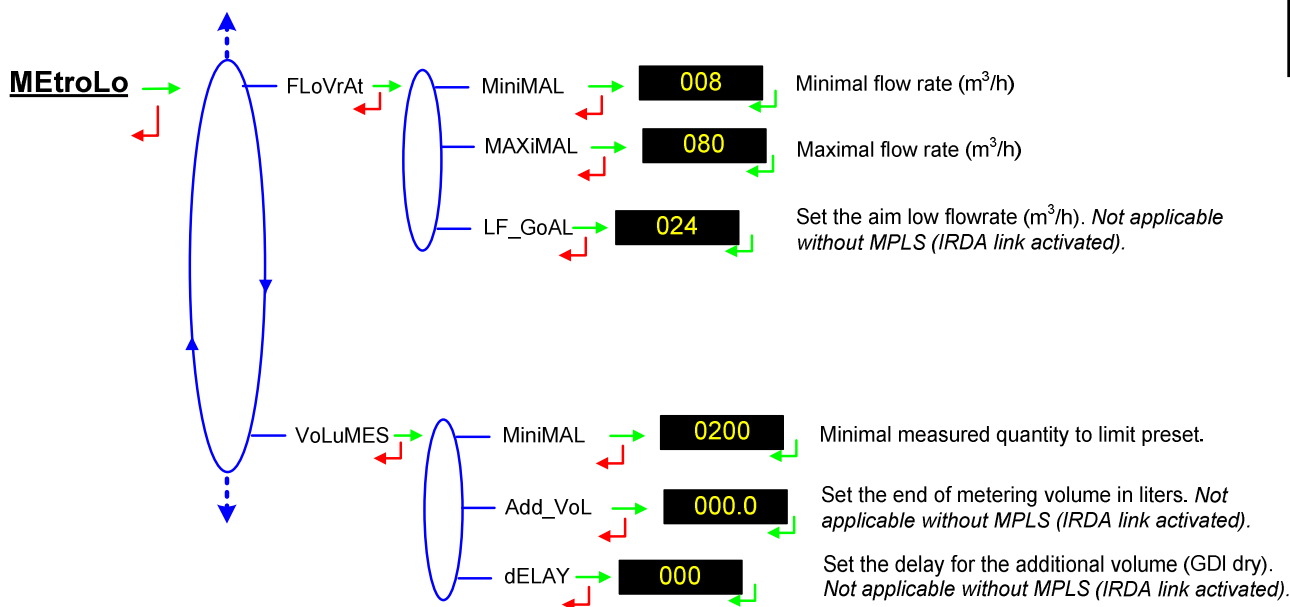

METROLOGICAL

5.3 TEMPERATURE, GAS DETECTORS, THRESHOLDS, CONTRAST, DATE, IRDA

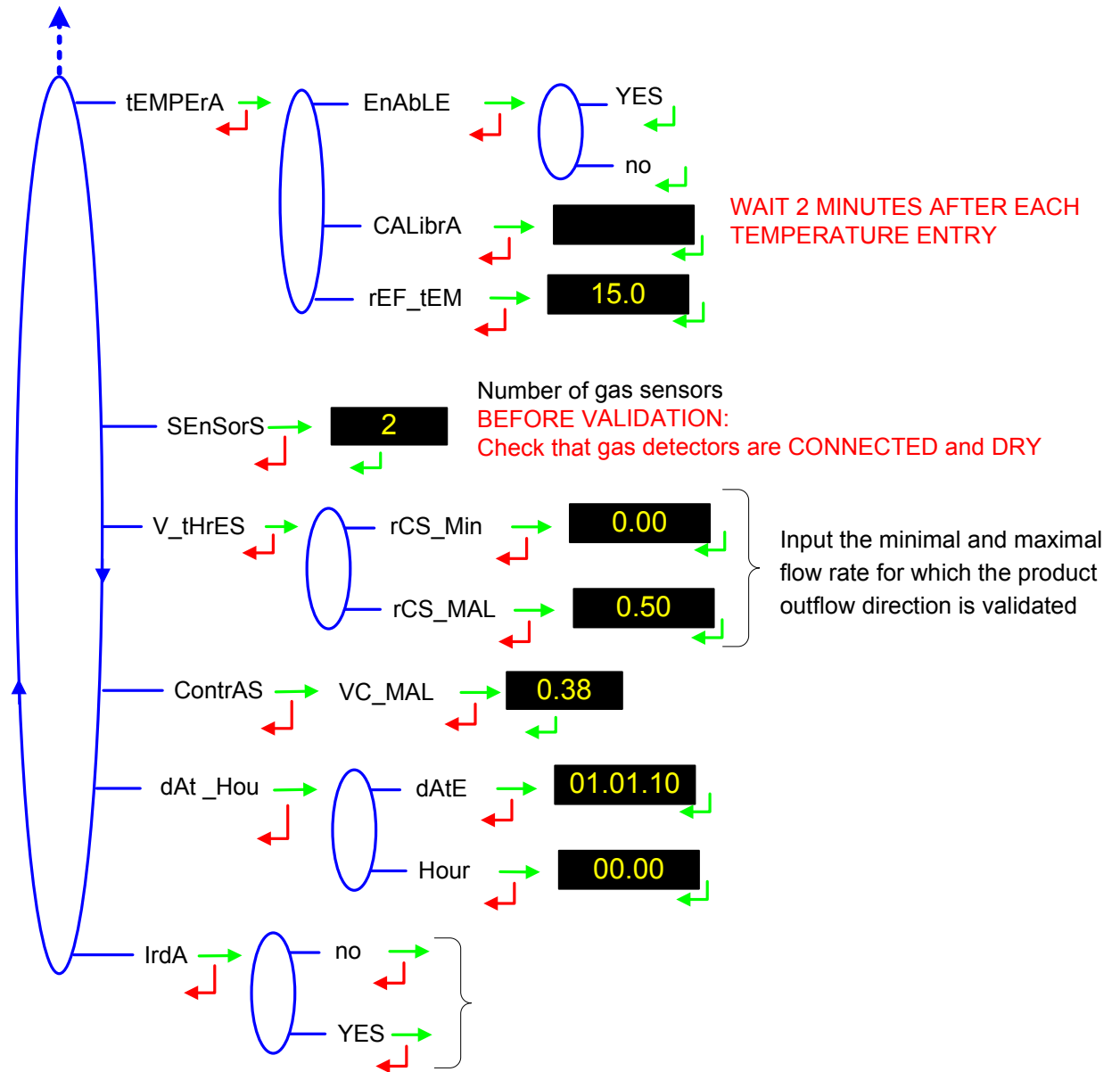

METROLOGICAL